

# Snow Performance Boost Cooler® Gas Water-Methanol Injection Kit Instructions

(Part#'s 210, 210-BRD)



**CAUTION:** You must completely read through these instructions before installing and operating this product. Failure to do so can result in damage to this product and the vehicle.

**Version: 1.0**



## BOOST COOLER™

Congratulations on your purchase of a Snow Performance Boost Cooler® Gas Water-Methanol Injection kit! **Keep these instructions for reference.** First locate the part# of your injection system which can be found on the front of the Boost Cooler® box. Use this number to identify which set of electrical and setting instructions to follow.

### Required Tools Needed For Install:

- Phillips/Flat Head Screwdriver
- Power Drill
- Razor Blade
- Preferred Electrical Connectors (Crimping/Stripping Tools, Blue Butts, Eye Hooks, Posi-Taps, Fuse Taps, Soldering Supplies etc)
- Spare 16 Gauge Wire (Optional Depending On Install)
- Open End Wrench / Socket Set
- 1/8" – 27 NPT Tap (Optional Depending On Install)

**Average Install Time: 4-6 Hours**



### TECH TIP

Locate the wiring diagram for your injection kit further in these instructions beginning on page 8 for overview of system layout before attempting install.

## Step 1 Self Sealing Low Level Sensor Install (Optional)

Although not required for kit operation, the low level sensor and yellow led are a great way to monitor the level of your water-meth tank. The level sensor is designed to turn on the led or alert the controller in some kits as soon as the level inside the reservoir reaches the level of the sensor.

Step 1: Remove plastic nut, plastic ring, and clear rubber gasket from level sensor assembly.

Step 2: Using a stepped drill bit. Drill the hole for the level sensor at the location in the tank you want to be alerted. Typical placement is 1/3<sup>rd</sup> of the tank height.



Step 3: Remove the cap from the tank and feed/pull wires through hole until level sensor is seated against plastic stopper.

Step 4: Reinstall the clear rubber gasket, plastic ring, and plastic nut onto the level sensor.

Step 5: Push clear rubber in until flush with outside of reservoir.

Step 6: Align the switch so the arrow is facing down. If arrow faces another direction the sensor will not operate.

Step 7: Tighten the plastic lock nut until the rubber gasket pushes firmly on the wall of the reservoir creating a leak free seal.



## Step 2 Tank Install

**OPTIONAL:** If desired you can use the stock windshield washer fluid tank as the tank for your water-meth system. Simply drill and tap a 3/8" NPT hole in desired feed spot for system and install the 3/8" NPT fitting into the tank using E-6000 sealant on threads/around area.

**BRAIDED LINE KITS ONLY:** If OEM windshield washer fluid tank and 3qt tank do not want to be used a upgrade exists to move your tank to the trunk of any vehicle (See Part# SNO-40012-BRD) and other larger trunk mount tank options (See Part# SNO-40014-BRD)

Step 1: Install 3/8" NPT to 1/4" Quick Connect fitting or 3/8" NPT to 4AN Elbow fitting into the bottom of the reservoir using E6000® sealant on the threads.

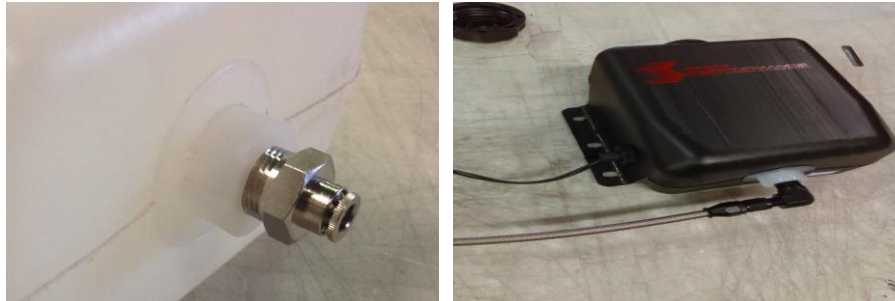

Step 2: After allowing the thread sealant to dry, fill reservoir with water and check for leaks around tank fitting and level sensor. If leak occurs use E6000® sealant.

Step 3: Install the 3qt. tank with four (4) #8x1&1/2" self-tapping screws and four (4) #8 washers (supplied) in desired mounting location. Typical placement is any void area inside the engine bay.



### TECH TIP

The reservoir should be installed above the pump, but below the nozzle. This keeps the pump primed and avoids fluid leaking into nozzle when not in use



**CAUTION:** To avoid gravity feeding of fluid with rear mount reservoirs, it is essential to use a solenoid upgrade (Part # SNO-40060 / SNO-40060-BRD). Do not operate your rear mount reservoir equipped vehicle without an anti-siphon solenoid installed.

### Step 3 Pump Install

**Braided Line Kits Only-** Install (2) 3/8" NPT to 4AN Straight fittings into the pump inlet and outlet using E6000® sealant on the threads. Do not overtighten as damage to the pump housing can occur.

**Quick Connect Kits Only-** Remove the blue rubber plugs from the quick-connect fittings by first pushing the plug toward the pump, hold the grey collar against the pump, and gently pull the blue plug from the fitting. Warning: Pulling against the quick connects with excessive force may cause fitting damage.

Step 1: Position the fluid pump so that the inlet is positioned at or below the lowest point of the reservoir, and within two feet of the reservoir. (Pump can be installed in any orientation). This will ensure the pump is primed with fluid for optimal flow and pressure to the nozzles.

**\*\*Arrows on the pump inlet and outlet indicate the direction of fluid flow\*\***



Step 2: Install the fluid pump with four (4) #8x1&1/2" screws and four (4) #8 washers (supplied) in desired mounting location.

Step 3: Fit the high temp nylon tubing or braided line between the tank outlet fitting and the pump inlet, ensuring there are no kinks in the line and there is no stress on the fittings. Sharp kinks/bends can cause a leak in the system.

**Braided Line Kits Only-** Using the 2' or 1' stainless braided line section supplied in the kit connect the tank outlet to pump inlet.

**Quick Connect Kits Only-** Once high temp nylon is measured from tank outlet to pump inlet cut tubing using razor blade. Remove any burrs so that the fluid line properly seals against the internal o-rings inside the quick connect fittings. Insert tubing into the quick connects until fully seated, and pull lightly against quick connects to ensure proper installation between tank outlet to pump inlet



**CAUTION:** Pump must be shielded from road debris and direct tire wash. Failure to do so will result in pump failure.

## Step 4 Nozzle Selection

Hyper-Sonic® Nozzle Identification Chart:

Nozzle Number (Stamped On Side Of Nozzle)	Nozzle Size
1	60 ML/MIN
2	100 ML/MIN
3	175 ML/MIN
4	225 ML/MIN
5	375 ML/MIN
6	625 ML/MIN

Locate your Hyper-Sonic® water-methanol nozzles in the kit and compare the number stamped on the side to the above chart to determine its size. Nozzle sizing is determined by horsepower (which approximates the engine airflow) and boost (which approximates intake charge heat).

Determine your vehicle HP and boost/or no boost (N/A) and determine what size nozzle is needed for your application using the nozzle selection chart below. If you are unsure what nozzle to run with your given HP and boost send a email to [tech@snowperformance.net](mailto:tech@snowperformance.net) for assistance.

Forced Induction	Nozzle Size
200-400 HP	#3 175 ML/MIN
400-600 HP	#5 375 ML/MIN
600-800 HP	#6 625 ML/MIN

Naturally Aspirated	Nozzle Size
200-350 HP	#1 60 ML/MIN
350-650 HP	#3 175 ML/MIN
650-850 HP	#5 375 ML/MIN

Seal the appropriate nozzle into the nozzle holder fitting using E6000® sealant on the nozzle threads.

**\*\*The end of the nozzle with the fine mesh screen should be inserted into the nozzle holder\*\***



Correct



Correct

**\*\*Teflon sealants are not compatible with methanol, and should not be used with the install of your Snow Performance Boost Cooler®\*\***

## Step 5 Nozzle Mounting

Typical nozzle placement is approximately 6" or less before the throttle body inlet on the vehicle but the nozzle can be installed anywhere on the intake pipe after a intercooler outlet/supercharger outlet/turbo outlet. The nozzles should always be placed after an intercooler due to the possibility of the narrow passages and loss of air velocity leading to puddling. Nozzles should also be mounted after a MAF sensor due to the possibility of faulty readings. Nozzles may be mounted before a positive displacement supercharger.

Many options are offered to mount your nozzle including

**Mounting for metal and rigid plastic:** Drill and tap the intake tube with a 11/32" drill bit and a 1/8"-27 NPT thread tap in desired nozzle mounting location. \*\*\*To prevent debris from entering the engine, remove the intake tube from the vehicle prior to drilling\*\*\*

**Mounting in rubber boot (Nozzle Mount Adapter Part# SNO-40110):** This sandwich adapter allows a secure threaded connection in any rubber intake boot for water-methanol nozzles.

Install the nozzle at a 90° angle to the direction of airflow, and so that the nozzle tip is flush with the inside of the intake tube or protruding slightly to ensure an uninterrupted spray pattern. Ensure the nozzles cone of spray has no obstructions near the mounting location.

- Install the nozzle assembly into the threaded intake tube using E-6000 sealant on the nozzle threads.
- Using a open end wrench, tighten the nozzle assembly ½ turn past finger tight so that the nozzle head is flush with the inside of the intake tube.
- Re-install the vehicle's intake tube into its proper mounting location.

## Step 6 High Flow Check Valve Install

The check valve assembly (35 PSI Crack Pressure) will ensure that boost pressure does not back-feed air into the system or siphon due to engine vacuum. Ensure the check valve is installed with the arrow pointing in the direction of flow. The Check valve may be installed anywhere between the pump and nozzles. In a dual nozzle application the check valve will be placed between the pump and T fitting.

**Quick Connect Kits Only-** Fit the NPT thread to push connect adapters in both sides of the check valve using E-6000 sealant on the threads. Press the high pressure tubing in each fitting, ensuring the check valve is oriented properly in the direction of flow.



**Braided line kits** - Fit the NPT thread to 4AN adapters in each side of the check valve using E-6000 sealant on the NPT threads **only**. Connect the 5 foot section of braided line from the pump outlet to check valve inlet and the 1' or 2' section of braided line from the check valve outlet to the nozzle holder inlet.



When running the high pressure tubing or braided line from the in line check valve to the nozzle holder location, care should be taken to avoid extreme heat such as exhaust manifolds as well as any area that may abrade the line due to engine vibration and torque over. Also, ensure the lines are clear of the serpentine belt system.

### **Step 7 Electrical / Injection Settings**

 **CAUTION:** Disconnect the negative battery terminal while connecting wires to prevent electrical fire or damage to controller.

**To complete your water-meth install locate the part# for your injection kit and follow the subsequent electrical wiring diagram/instructions. The wires on the level sensor / LEDs are interchangeable and it does not matter which wire connects to ground 12V source.**

## Part# 210 / 210-BRD

### Wiring Diagram

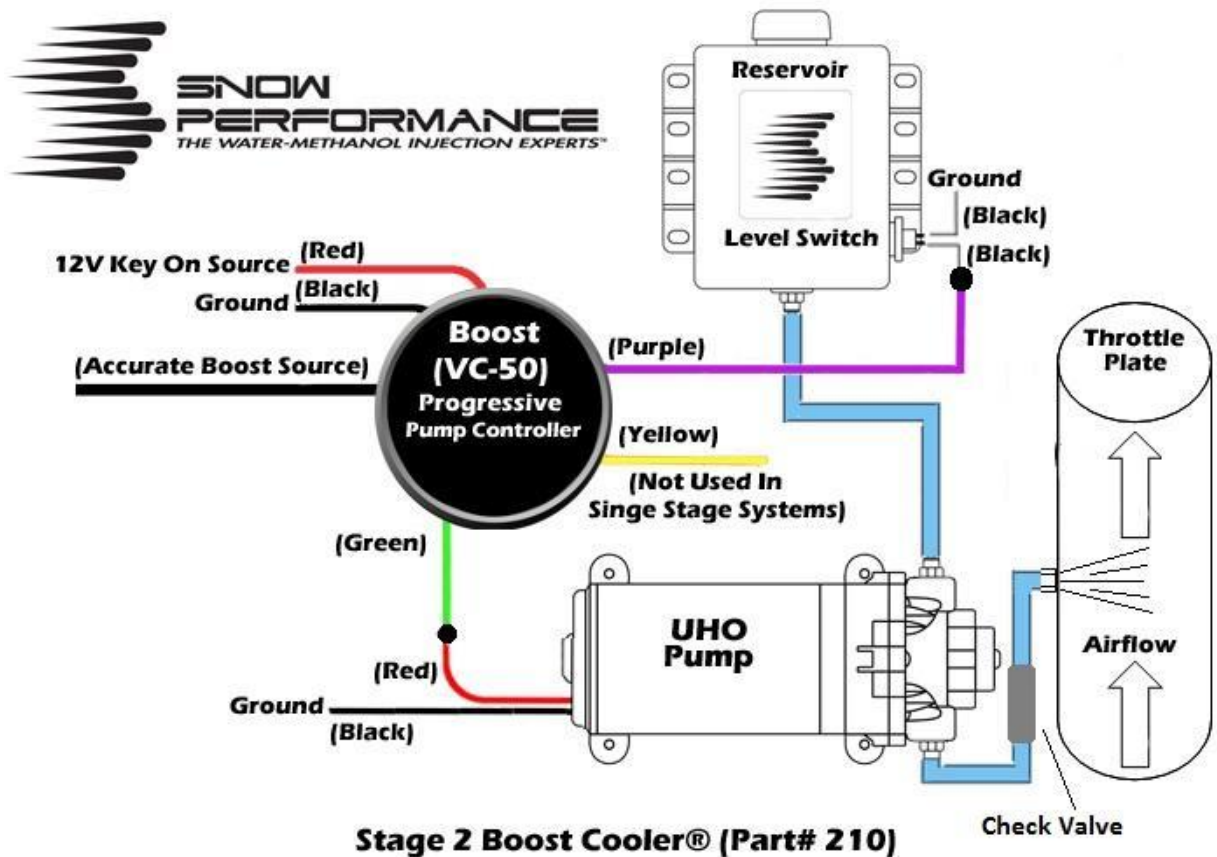

### Step 1 VC-50 Wiring/Boost Source

Step 1: Mount controller in desired location using a 52 mm gauge pod.

Step 2: Slide boost hose (black silicon hose supplied in kit) over the black boost line coming from the controller and secure with a wire tie. Connect other end of black silicon hose to accurate boost source using included boost "T" fitting.

Step 3: Using preferred electrical fitting connect BLACK wire to good ground location.

Step 4: Using preferred electrical fitting connect GREEN wire to Pump RED power wire.

Step 5: Using preferred electrical fitting connect PURPLE wire to one level switch black wire. Using preferred electrical fitting connect other level switch black wire to good ground location. These wires are interchangeable and either one can connect to controller/ground.

Step 6: Using preferred electrical fitting connector connect RED wire to 12Volt key on power source.

Step 7: YELLOW wire is not used in this install and can be tied out of the way.



## Step 2 VC-50 Injection Settings / Screens

### Main Screen

- Main Screen (see right) is used to monitor boost pressure, injection, low level, second stage activation, and to prime the system.
  - To prime the system press the red button underneath “P”. This will command 100% injection briefly to fully prime the system. ONLY ENGAGE PRIME WHEN ENGINE IS RUNNING!
  - Boost pressure is displayed in PSI on the upper left of the screen
  - Percentage of Injection is displayed using the graph in the middle of the screen. When injection is turned “Off” the graph will display the text “Off”.
  - When a low level situation occurs the outside of the screen will blink yellow alerting the user to fill the water-methanol reservoir.
  - (Dual Stage Systems Only) When a second stage of water-methanol is activated an asterisk will appear where “PSI” is located alerting the user of both stages injecting.
  - To enter the setting screens press the red button directly under the arrow on the bottom right.

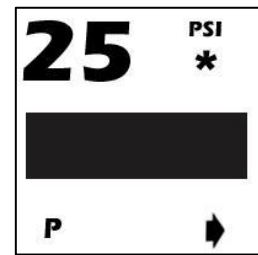

 **CAUTION: Do not operate the prime button when the engine is not running. Only engage priming of the system when the engine is on.**

### Injection Start

- Setting screen 1 (see right) is used to select what boost pressure will start injection. This should be set to 1/3<sup>rd</sup> to 1/2 the engines max boost output using the red buttons below the up and down arrows to adjust the PSI to desired setting. Press the red button underneath the arrow pointing right to move to setting screen 2 once desired setting is reached.

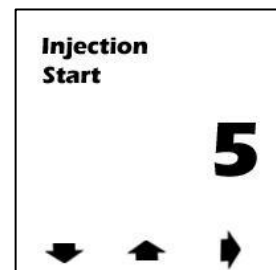

### Max Injection

- Setting screen 2 (see right) is used to select what boost pressure will correlate to max injection. This should be set to the vehicles maximum boost level using the red buttons below the up and down arrows to adjust the psi to desired setting. Press the red button underneath the arrow pointing right to move to setting screen 3 once desired setting is reached.

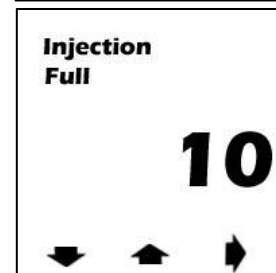

### Second Stage Nozzle “Power Nozzle” (Not Used)

- Setting screen 3 (see right) is used to select what boost pressure a second stage of injection will be triggered. If a second stage of injection is not being used this must be set above 50 PSI to the “OFF” setting to avoid a fault code. If a second stage is being used, the boost pressure must be set to a higher value than the “Injection Full” value.

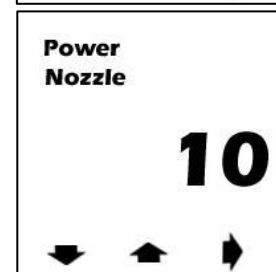

## Text Color

- Setting screen 4 (see right) is used to select what text color will be displayed on screen. Using the red buttons below the up and down arrows adjust the color to the desired setting (Red, Blue, Green, Yellow, Orange, Purple, White) are available. Press the red button underneath the arrow pointing right to move to setting screen 5.

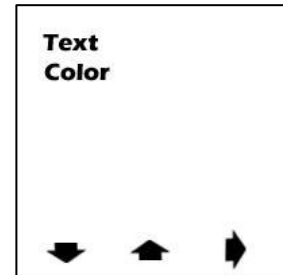

## Graph Color

- Setting screen 5 (see right) is used to select what graph color will be displayed on screen. Using the red buttons below the up and down arrows adjust the color to the desired setting (Red, Blue, Green, Yellow, Orange, Purple, White) are available. Press the red button underneath the arrow pointing right to move to setting screen 6.

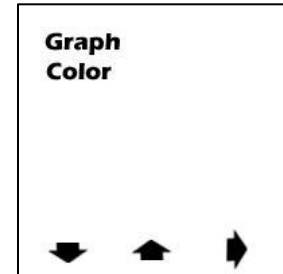

## Injection On/Off

- Setting screen 6 (see right) is used to toggle between on/off mode. In "ON" mode injection will take place based off the boost settings in the unit. In "OFF" mode no injection will take place and the "OFF" icon will be shown on the main screen. In this mode the controller will only function as a boost gauge.



**TECH TIP** In most applications, the start setting should initially be set at  $\frac{1}{2}$  of full boost pressure so that boost levels in normal driving do not trigger injection needlessly. The full setting should be near the vehicle's max boost pressure. Start tuning by carefully trying lower start point settings. If bogging is experienced at the onset of injection, move the start point back up a small amount. Then try lower and lower points for the full setting. If bogging is experienced as injection ramps up, turn the full point back up to a safe level. The engine should run with no bogging or miss-fires. Be sure to make small changes and then test them each time to avoid any drastic differences in injection.

## Step 3 Testing the System

You are now complete with your Stage 2 Boost Cooler Install. Check the system for leaks and verify system wiring. To test the system follow the below steps.

Step 1: Arm the system by putting the key in the ignition

Step 2: Make sure fluid is in the water-meth tank

Step 3: Remove nozzle from intake location and place in highly visible area

Step 4: Hit the prime button on the VC-50 controller. The system should engage and fluid should be atomized out of the nozzle.

Step 5: Enjoy increased octane! See tuning tips / FAQ at the end of these instructions for more info.

## **VC-50 Fault Alerts**

### **Low Level Alert**

- When the fluid in the reservoir is running low the border of the graph for injection will blink yellow alerting the user to fill the water-methanol reservoir.

### **Clogged Line**

- In the event of a clogged line the psi reading on the main screen will turn to stars and begin flashing. If this occurs, fix the problem and press the middle red button to clear the code.

### **Broken Line**

- In the event of a broken line the psi reading on the main screen will turn to stars and begin flashing. If this occurs, fix the problem and press the middle red button to clear the code.

### **Solenoid Not Engaging (Dual Stage Systems Only)**

- In the event of a solenoid not opening to engage a second stage of water-methanol the psi reading on the main screen will turn to stars and begin flashing. If this occurs, fix the problem and press the middle red button to clear the code.

## **Tuning Quick Reference**

The power potential of the system is realized through increased boost and/or timing. The large gains on octane and cooling provided by the system make this possible, even on standard pump fuel.

The Boost Cooler® adds an alternate fuel source as well as significantly cools combustion. With the Boost Cooler®, one does not need to cool combustion with overly rich air/fuel ratios. To minimize combustion quench, you should start with an air to fuel ratio of 12.0-12.5:1. Injecting water/methanol lower than 3300-3500 RPM could result in combustion quench.

All vehicles are different. If the engine bogs or loses power, then injection is starting too early, the quantity is too much, or there is not enough methanol in the mixture (50/50 water/methanol recommended).

# Maintenance

Remove nozzle(s) and clean screen filters once per year using a calcium removing formula such as CLR®

The Boost Cooler® has been designed to operate with high concentrations of methanol. Oil or other additives are not required for system lubrication, and can cause damage to the system.

Contaminants in the fluid such as dirt can damage the system. Ensure that dirt and debris do not fall into the tank. This can lead to solenoid/pump failure.

Do not use Teflon tape or paste to seal connections. These sealers are not as effective as the E-6000 sealant provided and can break down over time with high methanol use, clogging components.

## Water-Meth FAQ

### **Q: How long will a 3 Qt tank of water/methanol last?**

**A:** This depends on a number of variables (HP, injection system, settings, driving style, etc.) For most gasoline engines in the 250-550 HP range the standard 3Qt reservoir will last around two 12-15 gallon tanks of gasoline.

### **Q: What fluids can I use in my water/methanol system?**

**A:** Boost Juice®: This is the best fluid to use and is Snow Performance's 49% methanol, 51% water mixture that can be shipped to your door or picked up at a local dealer. (If you are using your washer reservoir as the injection tank, Boost Juice® is a great washer fluid and can be injected directly on the windshield without damaging the vehicle.)

- Windshield Washer fluid: Only if it is blue in color and rated for -20 deg F. It should have no special additives. This means it is safe to use and made of 30% methanol, 70% water. If it is another color or another temperature rating, **do not use it**. You can "spike" your Blue -20 Washer fluid to a 50% mixture by adding 3 12OZ yellow bottles of Heet® gas-line-antifreeze to every gallon of washer fluid.
- Mix your own: You just need to make sure the methanol is "neat" and contains no lubricants or other additives. We recommend a 50% mixture by volume of M-1 pure grade methanol and distilled water.
- Do NOT use E85 or any other fluid with gasoline mixed in. It will destroy the fluid delivery part of your Boost Cooler® and instantly void the warranty.

### **Q: Do I have to have a custom dyno tune with a water-meth kit?**

**A:** While extremely recommended for maximum performance and safety while injecting water-methanol a custom tune is not necessary to operate the vehicle as long as the following are met. 1) The vehicle is not utilizing a existing custom tune for the water-methanol 2) A low methanol concentration is being injected and not severely effecting the air/fuel ratio. Consult your local dyno professional for tune / recommendation.

**Q: What ratio of water/methanol is recommended?**

**A:** A 50/50 ratio is recommended for maximum performance and safety. Ratios of anywhere from 30% to 50% methanol work well and deliver excellent octane gains and cooling without over richening the air fuel ratio.

**Q: Can I use pure methanol?**

**A:** While all components of Snow Performance systems are designed to be able to handle 100% pure methanol, it is not recommended for a number of reasons.

- Safety: Pure methanol is easy to ignite with a low 140F degree flash-point and burns with an invisible flame.
- Performance: Water absorbs almost twice as much heat as methanol in the intake and inside the combustion chamber. Water cannot be flash-ignited, so has what is almost an infinite octane number. In the government studies for WWII piston-powered aircraft, 50/50 water-methanol was found to be the best fluid to use for auxiliary fluid injection.

**Q: Can I inject water/methanol with nitrous?**

**A:** Yes! With nitrous, water/methanol injection allows the use of more timing advance even with large (250HP+) quantities. The cooling effect of the water/methanol inside the combustion chamber also makes for reduced peak combustion temperatures.

**Q: Should I mount my nozzles pre or post turbo/supercharger?**

**A:** • Centrifugal Supercharger/Turbo: Never mount an injector nozzle before a centrifugal supercharger or turbocharger compressor. Sending fluid through the compressor wheel that spins anywhere from 50,000rpm to 250,000rpm can erode the leading edges of the fine aluminum. Studies performed by SAAB, concluded that pre-turbo injection will over time cause cavitation on the turbo wheel leading edges.

• Positive Displacement Supercharger: Mounting the nozzle before this style of blower is perfectly safe and actually provides some additional benefits. The small amount of water-methanol fluid isn't harmful to any rotor seals or surfaces or coatings. Additionally, it keeps the rotors and housing MUCH cooler, which reduces heat transfer to the rest of the intake and air charge.

## Disclaimer

Do not use this product until you have carefully read the following agreement.

This sets forth the terms and conditions for the use of this product. The installation of this product indicates that the BUYER has read and understands this agreement and accepts its terms and conditions. Performance products by their nature are designed to increase horsepower and performance not engineered in the original vehicle and the increased stress could result in damage to related systems. This is a high performance product – use at your own risk. Snow Performance Inc., Its agents, employees or owners shall not be under any liability whether in contract or otherwise whether or not resulting from our negligence or contents of information supplied for any damage or loss resulting from such information. The **BUYER** is responsible to fully understand the capability and limitations of his/her vehicle according to manufacturer specifications and agrees to hold the **SELLER** harmless from any damage resulting from failure to adhere to such specifications. The **SELLER** disclaims any warranty and expressly disclaims any liability for personal injury or damages. The **BUYER** acknowledges and agrees that the disclaimer of any liability for personal injury is a material term for this agreement and the **BUYER** agrees to indemnify the **SELLER** and to hold the **SELLER** harmless from any claim related to the item of the equipment purchased. Under no circumstances will the **SELLER** be liable for any damages or expenses by reason of use or sale of any such equipment. The **BUYER** is responsible to obey all applicable federal, state, and local laws, statutes, and ordinances when operating his/her vehicle, and the **BUYER** agrees to hold **SELLER** harmless from any violation thereof. The **SELLER** assumes no liability regarding the improper installation or misapplication of its products. It is the installer's responsibility to check for proper installation and if in doubt, contact the manufacturer.

Notes: The contents of this document are subject to change without prior notice. No part of or this entire document may be reproduced in any form without prior written permission of Snow Performance, Inc. under the copyright except for private use. The names, addresses and telephone numbers mentioned are current as of October 1, 2017. Note that this information is subject to change. Please refer to [www.snowperformance.net](http://www.snowperformance.net) for current information.

### **Snow Performance 1-Year Warranty Policy:**

Snow Performance, Inc. warrants that the Product shall conform to and perform in accordance with published technical specifications and shall be free of defects in materials and workmanship for 1-year providing:

1. You are the original purchaser and provide proof of purchase.
2. The system was purchased from a Snow Performance Authorized Dealer at MRP pricing set by Snow Performance.\*

**\*No warranty will be offered for any Snow Performance products if purchased below MRP. For MRP pricing of your product check [www.snowperformance.net](http://www.snowperformance.net).**

3. An RMA # has been attained and is displayed on package containing returned part.
4. Parts Warranty ~ 90 day warranty on parts purchased separately if used in conjunction with a Snow System. No warranty implied if used with a non-Snow part/system. Subject to Snow's inspection of the product, Snow will remedy defects in materials and/or workmanship by repairing or replacing, at Snow's option, the defective product without charge for parts or labor, subject to the limitations and exclusions described in this warranty.

This warranty does not cover problems caused by normal wear and tear including aesthetic oxidation of surfaces, accidents, unlawful vehicle operation, or modifications or repairs to product not performed or authorized by Snow. This includes any product that is disassembled or taken apart for any reason.

In addition, this warranty does not cover problems resulting from conditions beyond Snow's control including, but not limited to, theft, misuse, overloading, or failure to assemble, mount or use the product in accordance with Snow's written instructions or guidelines included with the product or made available to the original retail purchaser. In the event of failure, Snow will repair or

replace the part at Snow's sole discretion. Failures resulting from misapplication or misuse of the Product, failure to adhere to any specifications or instructions, or failure resulting from neglect, abuse, accidents, or act of nature are not covered under this warranty.

Warranty service may be obtained by emailing [tech@snowperformance.net](mailto:tech@snowperformance.net) with a copy of your purchase invoice for the product, getting an RMA (Return Merchandise Authorization) number, and delivering the part to Snow. Customer agrees to insure the Product or assume the risk of loss or damage in transit, to prepay shipping charges to Snow, and to use the original shipping container or equivalent. Shipping for Warranty replacement parts shipped outside the continental US will be charged to customer.

**Non-Warranty Repair/Retest**

Products returned due to damage or misuse and Products retested with no problem found are subject to repair/retest charges. Product will be returned to customer at customer's expense. A credit card number must be provided in order to obtain an RMA (Return Merchandise Authorization) number prior to returning Product.

**Distributor/Dealer Warranty:**

All customers/dealers must deal directly with Snow Performance to receive warranty. No warranty will be issued through a distributor for any reason.

**Return Policy:**

All returns must be called in for RMA #. Snow Performance will not take used kits or parts for refund. If you are returning an unused kit there is a 15% restocking fee minus shipping/handling. All returns must be made within 30 days of purchase date. No exceptions.

**LIMITATION OF LIABILITY:** REPAIR OR REPLACEMENT OF A DEFECTIVE PRODUCT IS THE ORIGINAL RETAIL PURCHASER'S EXCLUSIVE REMEDY UNDER THIS WARRANTY. DAMAGE OR INJURY TO THE ORIGINAL RETAIL PURCHASER, TO HIS OR HER VEHICLE, CARGO, OR PROPERTY, AND/OR TO ANY OTHER PERSON OR PROPERTY IS NOT COVERED BY THIS WARRANTY. THIS WARRANTY IS EXPRESSLY MADE IN LIEU OF ANY AND ALL OTHER EXPRESS WARRANTIES, WHETHER ORAL OR WRITTEN. SNOW'S SOLE LIABILITY IS LIMITED TO THE REMEDY SET FORTH ABOVE. IN NO EVENT WILL SNOW BE LIABLE FOR ANY DIRECT, INDIRECT, CONSEQUENTIAL, INCIDENTAL, SPECIAL, EXEMPLARY, OR PUNITIVE DAMAGES OR FOR ANY OTHER DAMAGES OF ANY KIND OR NATURE (INCLUDING, BUT NOT LIMITED TO, LOST PROFITS OR LOST SALES). SOME STATES DO NOT ALLOW THE EXCLUSION OR LIMITATION OF INCIDENTAL OR CONSEQUENTIAL DAMAGES, SO THE ABOVE LIMITATIONS MAY NOT APPLY TO YOU.